

Contents

1	KCLP0402CRSM	Medium Beam - NEMA 3	Pag. 2
2	KCLP0403CRSM	Wide Beam - NEMA 5	Pag. 3
3	KCLP0404CRSM	Extra Wide Beam - NEMA 4	Pag. 4
4	KCLP0405CRSM	Ultra Wide Beam - NEMA 5	Pag. 5
5	KCLP0406CRSM	Asymmetrical Beam - NEMA 5x6	Pag. 6
6	Assembly Specifications		Pag. 7
7	Determination of thermal shock resistance degree		Pag. 8
8	Packaging		Pag. 9
9	Materials / Use and Maintenance / Disclaimer		Pag. 10

KCLP04xxCRSM is the new Khatod's family of high-tech Reflectors meant for wide area applications, especially for lighting applications in any type of sport structures and environments, indoor and outdoor.

KCLP04xxCRSM Reflectors come in many models. They are square shaped – 50mm x 50mm – and consist of an array made of 4 reflectors, with a 25,4mm pitch between the optical foci. They perform a variety of NEMA Beam Angle Types, from Medium Beam (NEMA 3) to Ultra Wide Beam (NEMA 5) and an outstanding Asymmetrical Beam (NEMA 5x6). Made of black PC HT with aluminium reflective coating, the reflectors work perfectly within -30° to ~ 120°C temperature range.

KCLP04xxCRSM Reflectors are optimized for the most famous 3535 package LEDs with dome.

Perform high lighting efficiency, excellent luminous flux and great glare control.

They can be used individually or configured in multiple parts, so to create the perfect lighting fixture for your application, as linear lighting rows or in configurations of different shape and width.

The Reflectors are easily assembled by screw fixing.

KCLP0402CRSM - Medium Beam - NEMA 3

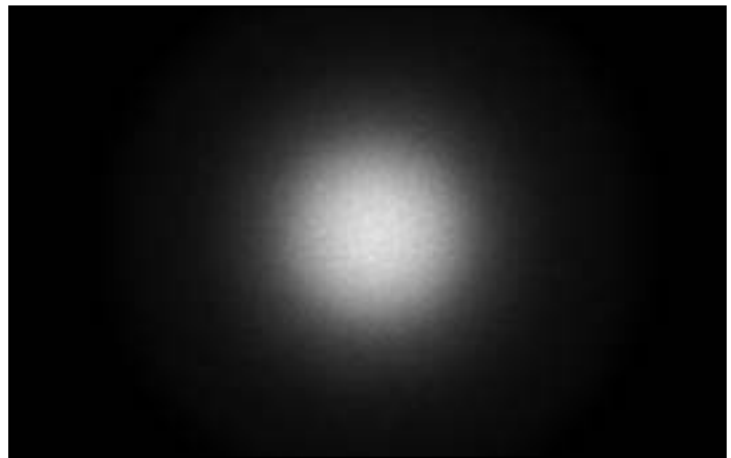
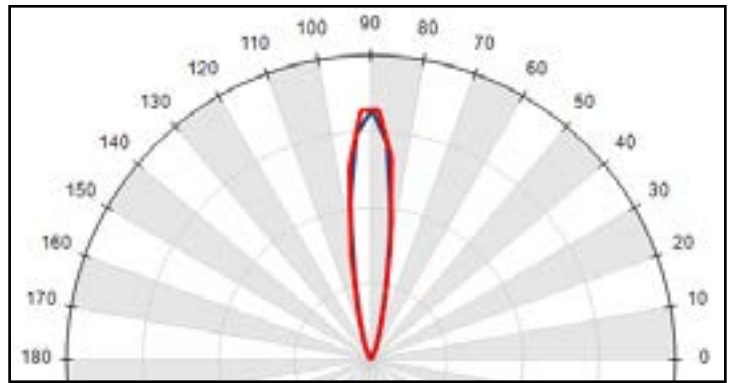
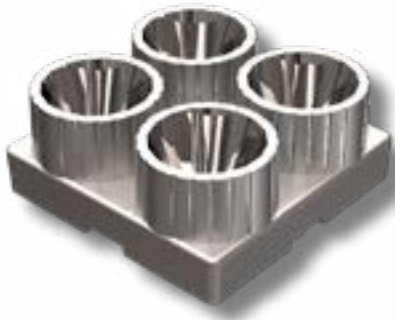

- Material = PC HT Black + Aluminium Reflective Coating (UL94 V0 on Request)
- Efficiency: over 88%
- Full angle at 50% from maximum: ~ 18°
- Full angle at 10% from maximum: ~ 38°
- The light spots here represented refer to tests carried out with LEDs with 3mm Dome and 2mm² LES, ~260lm@LED

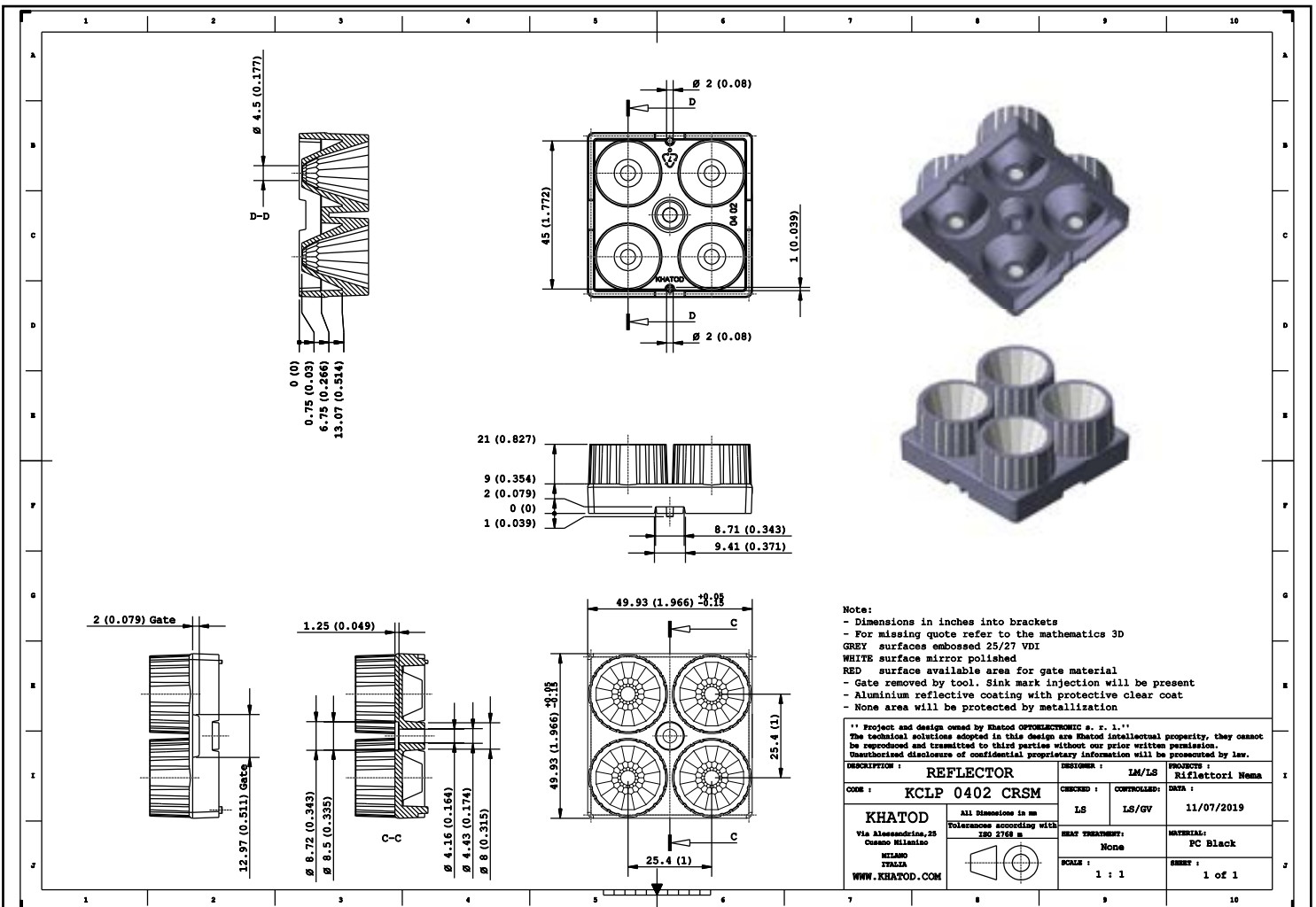

Note:
- Dimensions in inches into brackets
- For missing quote refer to the mathematics 3D
GREY surfaces embossed 25/27 VDI
WHITE surface mirror polished
RED surface available area for gate material
- Gate removed by tool. Sink mark injection will be present
- Aluminium reflective coating with protective clear coat
- None area will be protected by metallization

Project and design owned by Khatod OPTOELECTRONIC s. r. l.
The technical solutions adopted in this design are Khatod intellectual property, they cannot be reproduced and transmitted to third parties without our prior written permission.
Unauthorized disclosure of confidential proprietary information will be prosecuted by law.

DESCRIPTION :	REFLECTOR	DESIGNER :	LM/LS	PROCESSED :	Riflettori Nema
CODE :	KCLP 0402 CRSM	CHECKED :	LS	CONTROLLED :	LS/GV
Khatod Via Alessandro, 25 Cesano Maderno Milano ITALY WWW.KHATOD.COM		All dimensions in mm Tolerances according with ISO 2768 m		DATE :	11/07/2019
MATERIAL:			PC Black		
SCALE :			1 : 1		
SHEET :			1 of 1		

KCLP0403CRSM - Wide Beam - NEMA 5

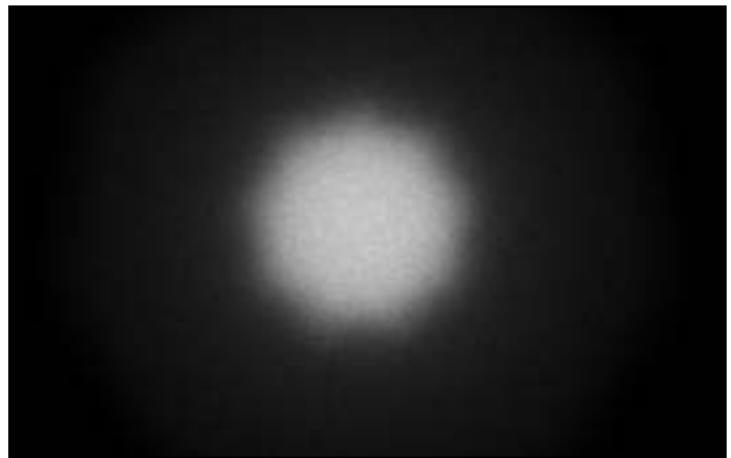
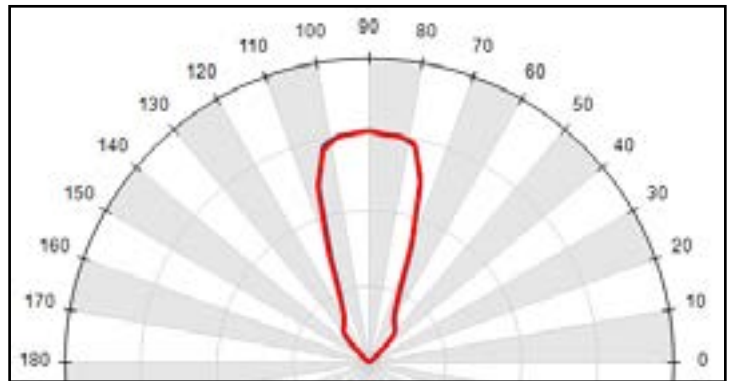

- Material = PC HT Black + Aluminium Reflective Coating (UL94 V0 on Request)
- Efficiency: over 85%
- Full angle at 50% from maximum: ~ 40°
- Full angle at 10% from maximum: ~ 88°
- The light spots here represented refer to tests carried out with LEDs with 3mm Dome and 2mm² LES, ~260lm@LED

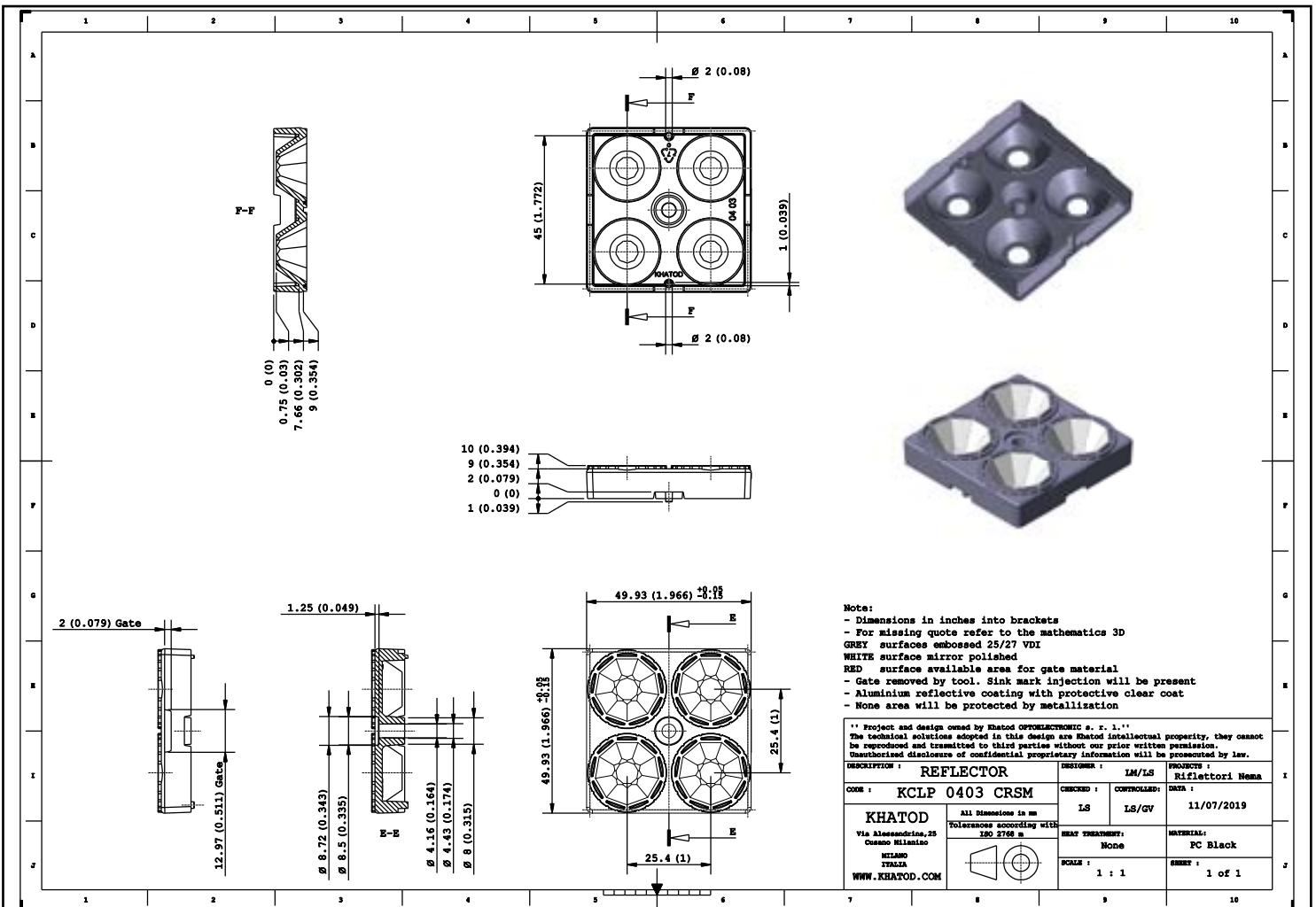

KCLP0404CRSM - Extra Wide Beam - NEMA 4

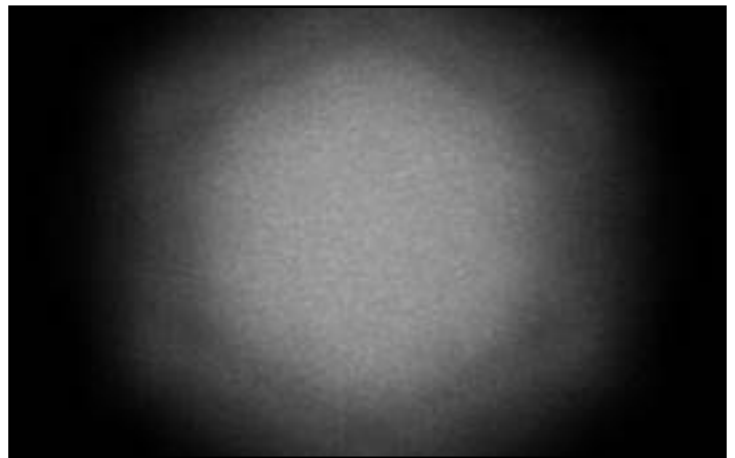
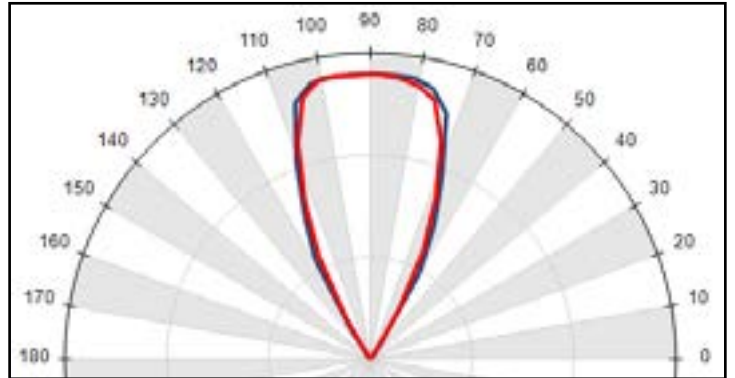

- Material = PC HT Black + Aluminium Reflective Coating (UL94 V0 on Request)
- Efficiency: over 89%
- Full angle at 50% from maximum: ~ 48°
- Full angle at 10% from maximum: ~ 65°
- The light spots here represented refer to tests carried out with LEDs with 3mm Dome and 2mm² LES, ~260lm@LED

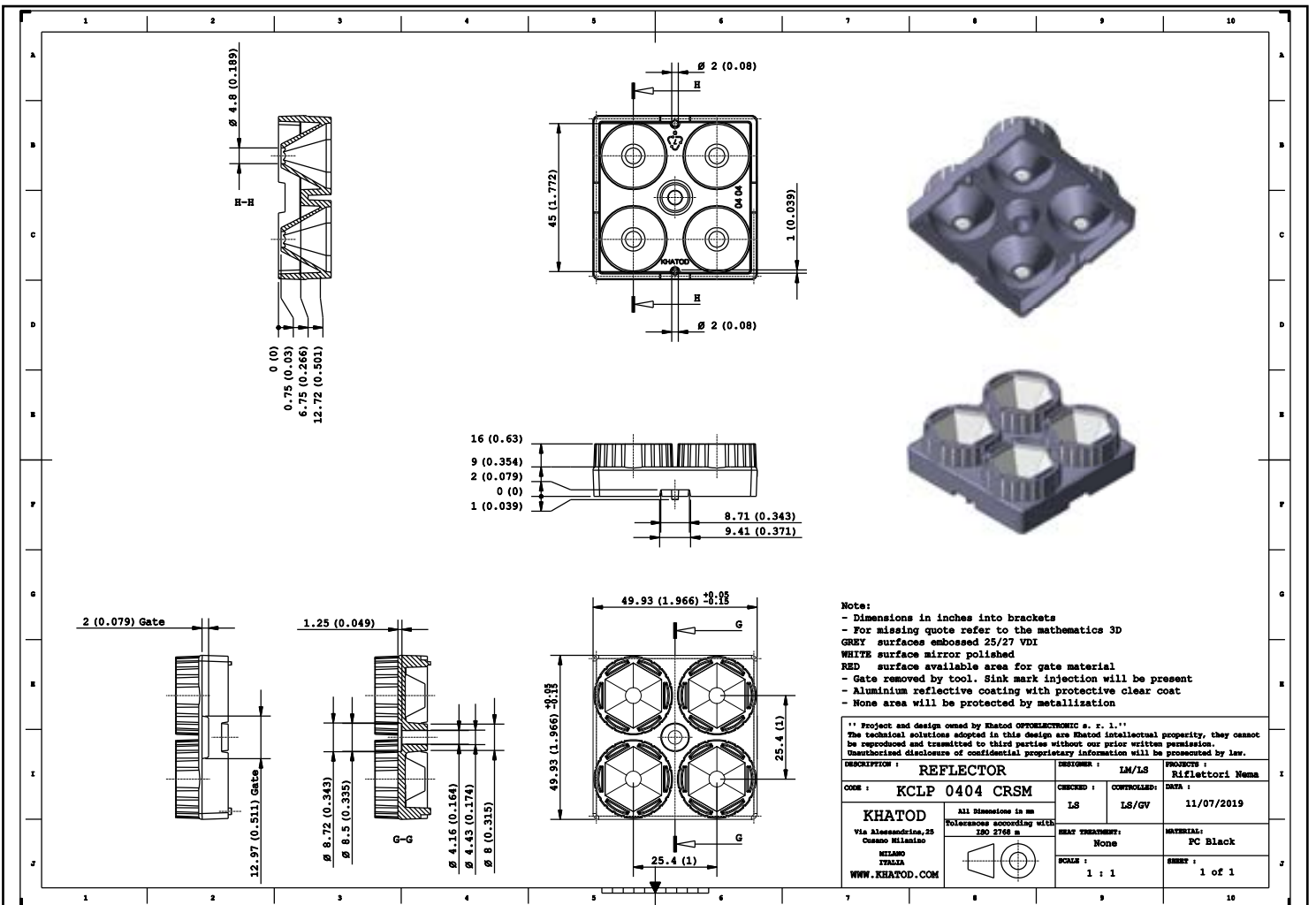

KCLP0405CRSM - Ultra Wide Beam - NEMA 5

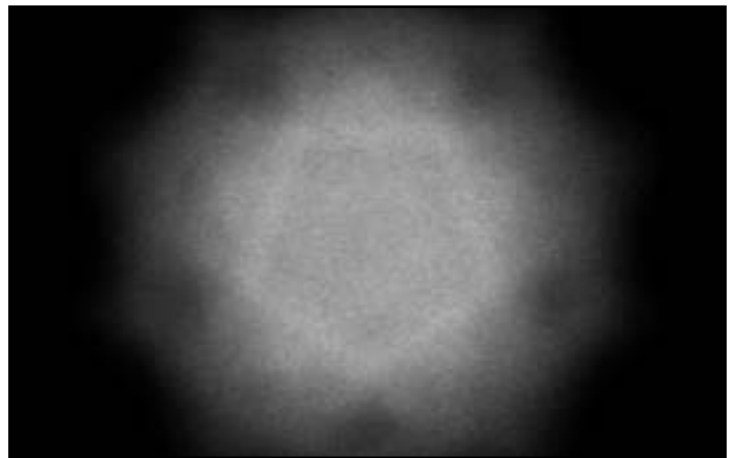
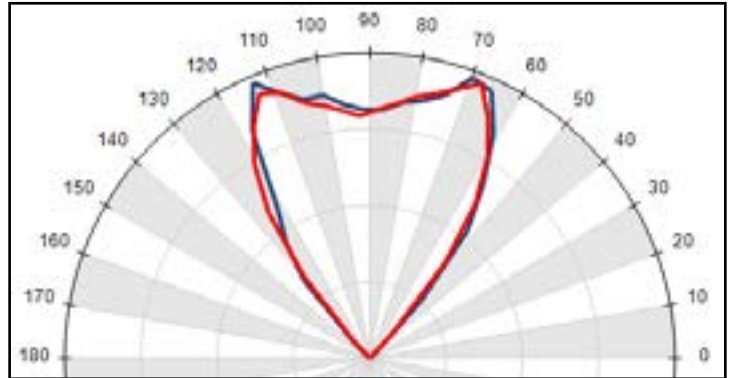

- Material = PC HT Black + Aluminium Reflective Coating (UL94 V0 on Request)
- Efficiency: over 88%
- Full angle at 50% from maximum: ~ 71°
- Full angle at 10% from maximum: ~ 87°
- The light spots here represented refer to tests carried out with LEDs with 3mm Dome and 2mm² LES, ~260lm@LED

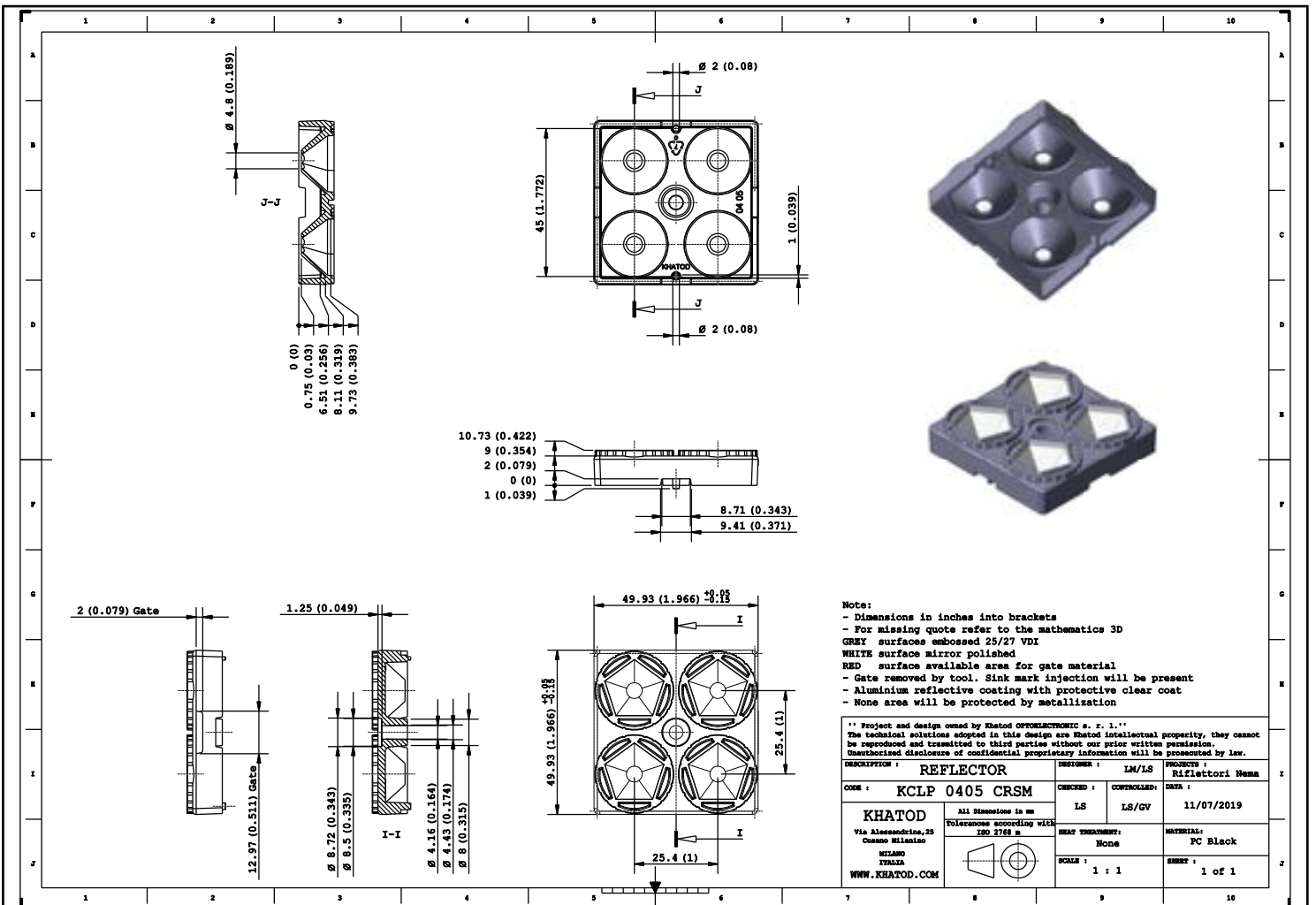

KCLP0406CRSM - Asymmetric Beam - NEMA 5x6

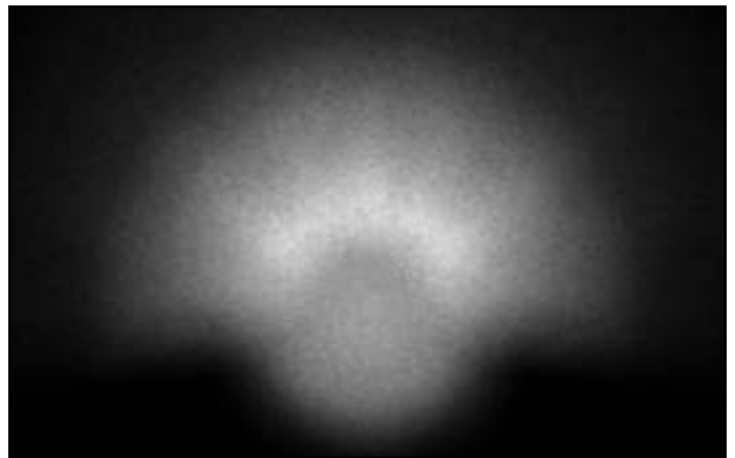
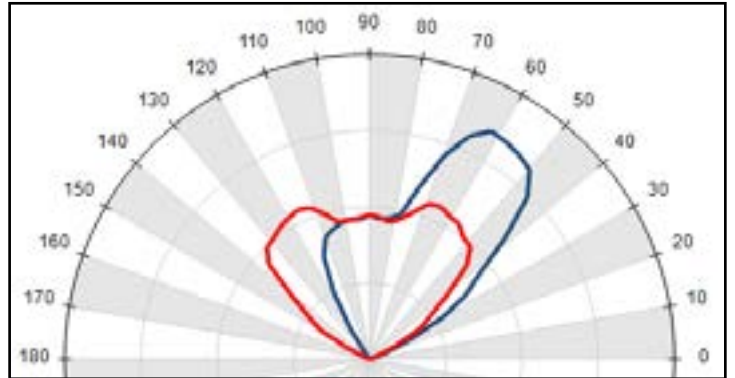

- Material = PC HT Black + Aluminium Reflective Coating (UL94 V0 on Request)
- Efficiency: over 95%
- Full angle at 50% from maximum: ~ 85°x105°
- Full angle at 10% from maximum: ~ 110°x130°
- The light spots here represented refer to tests carried out with LEDs with 3mm Dome and 2mm² LES, ~260lm@LED

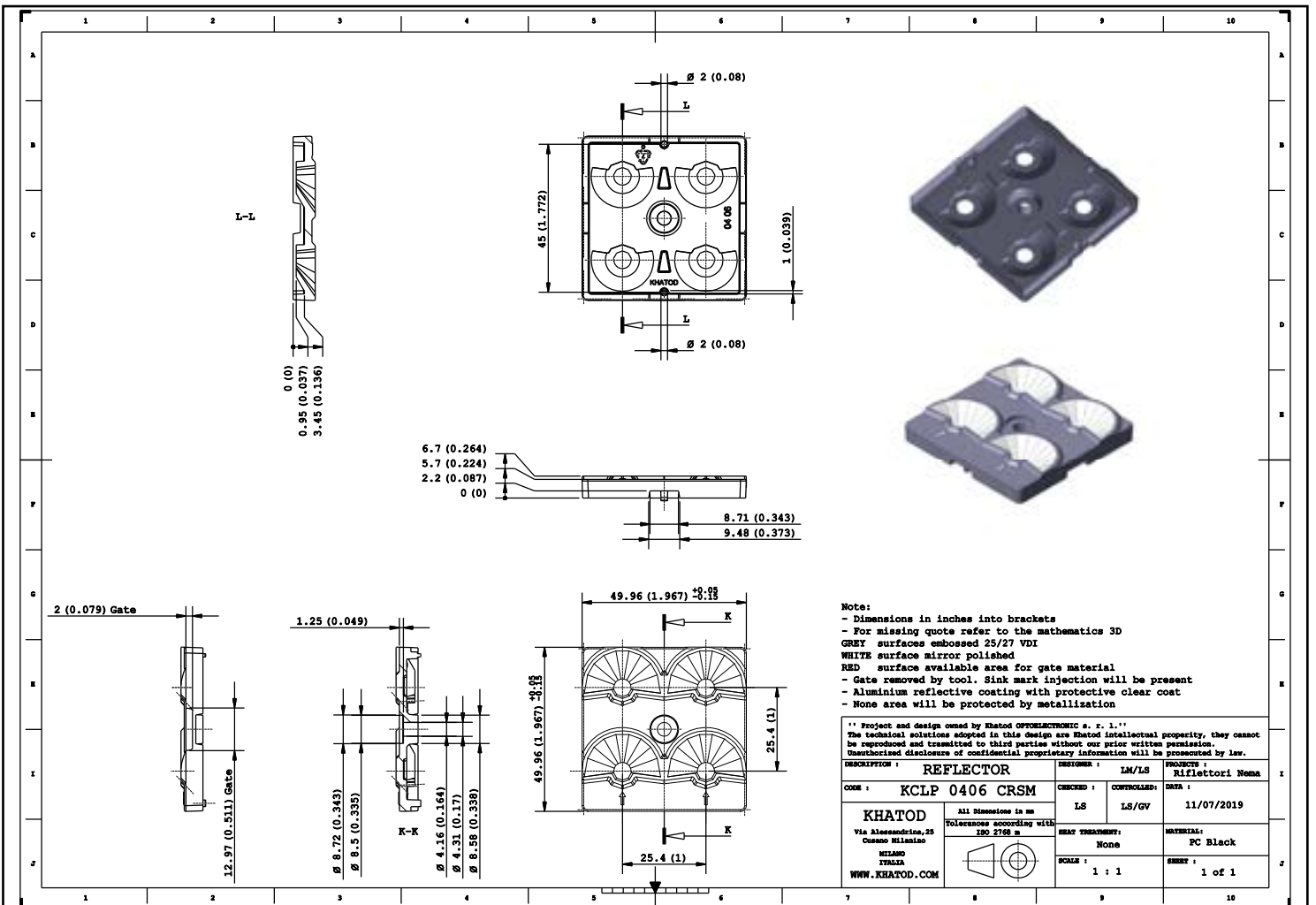

Assembly Specifications

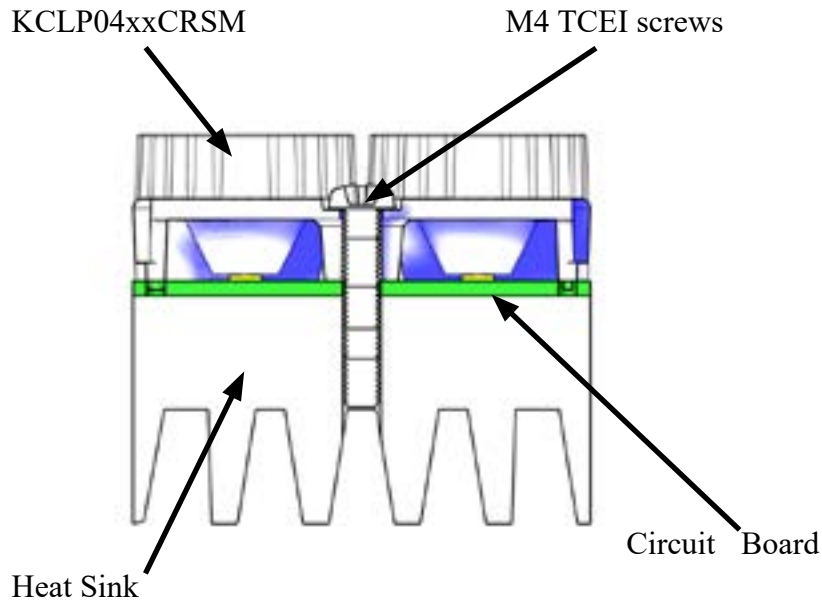

Use M4 TCEI screws

- M4: Maximum tightening torque ~ 0.8/1.2 Nm

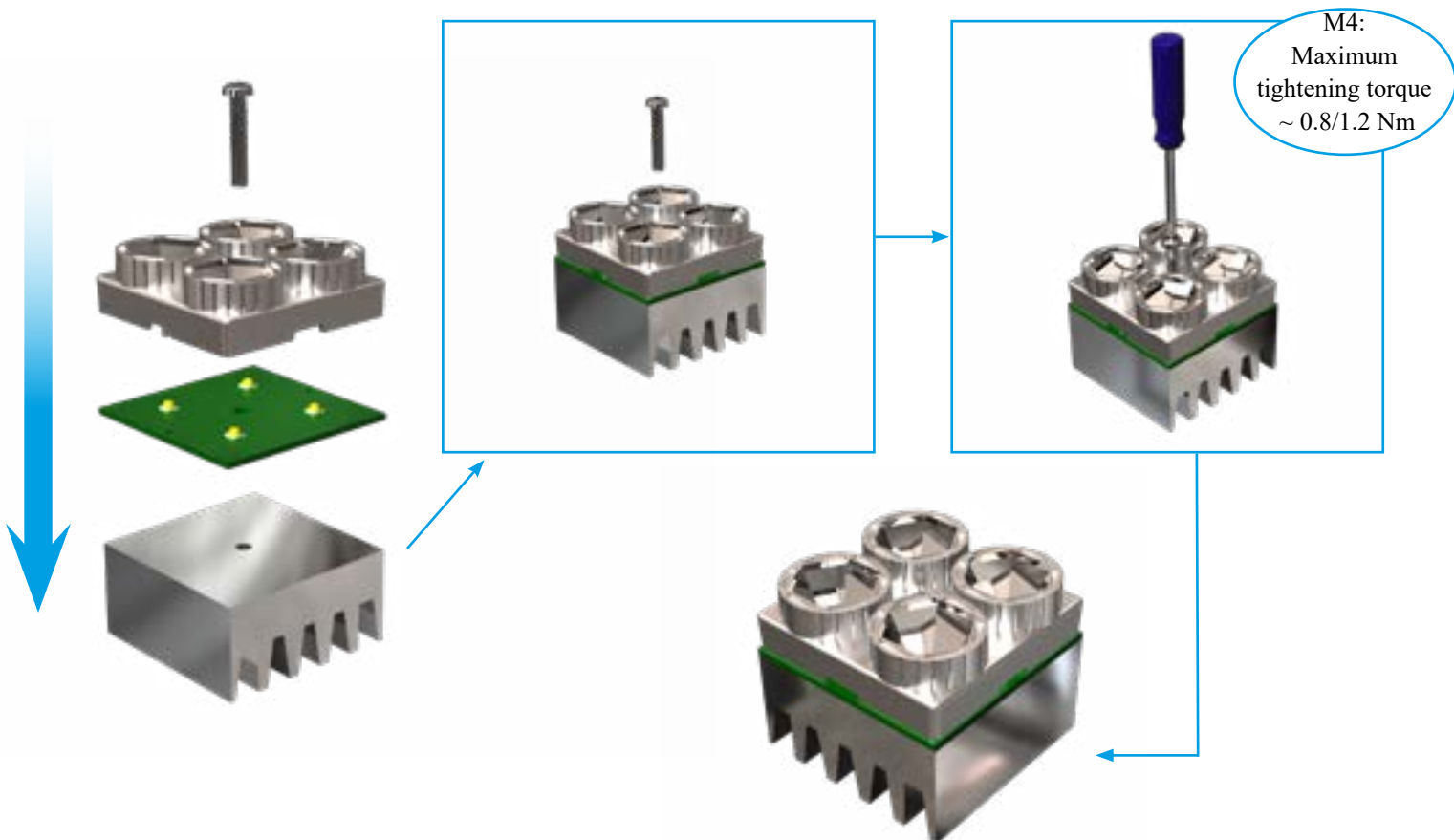

Determination of thermal shock resistance degree

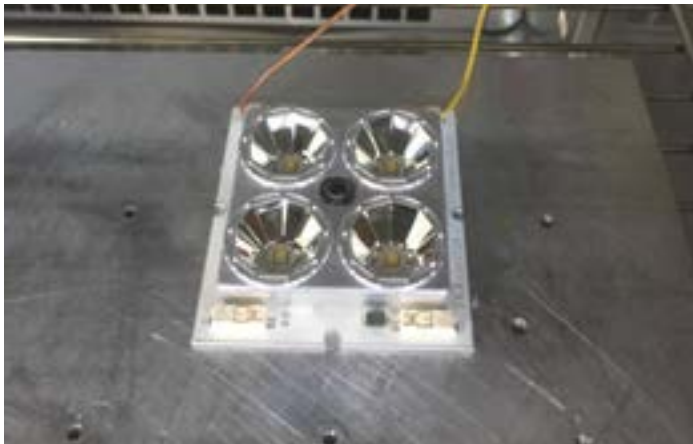

Initial Visual Inspection

Before starting with testing, a visual inspection was performed in order to check the integrity of the part under test.

The part resulted physically intact.

The reference temperature of the component under test is 60° C, and the test was performed with the PCB turned on. Reference PCB: 4 LEDs Samsung LH351B, current driven 700mA.

Photo: the part in the climatic chamber.



Temperature set in the climatic chamber

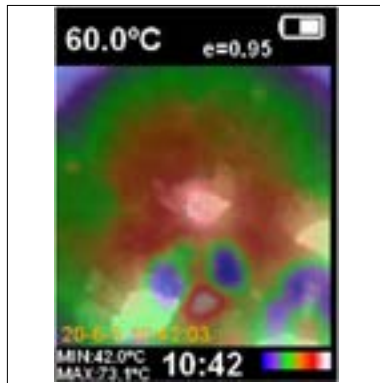

Temperature detected on the part by IR thermal camera

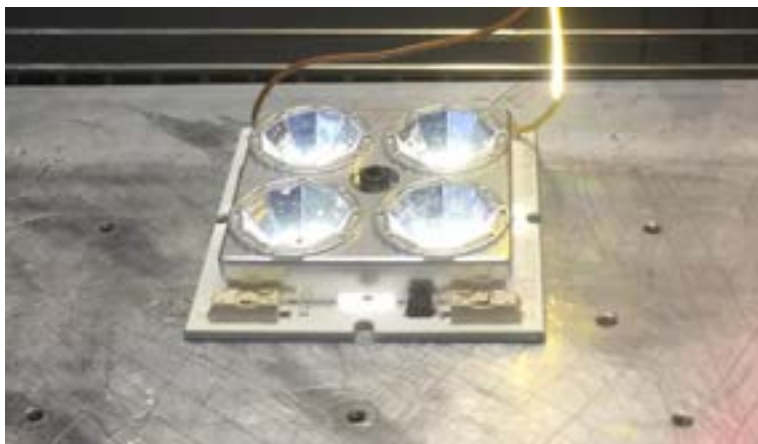

Final Visual Inspection

After testing, a final visual inspection was performed. The result was positive. (view photo)

Photo: the part in the climatic chamber after testing.

Based on the testing result, KCLP04xxCRSM test specimens proved to overcome the thermal stress test up to 60°C, without any physical deterioration of the material.

Packaging

KCLP0402CRSM

Item	Quantity	Total Parts	Size (L*W*H)	G.W.
skin-packed Cardboard	30 pcs per skin-packed Cardboard	30 pcs	--	--
Outer Box	13 skin-packed Cardboards per Outer Box	390 pcs	50*39*33 cm	2.7 Kg

KCLP0403CRSM

Item	Quantity	Total Parts	Size (L*W*H)	G.W.
skin-packed Cardboard	30 pcs per skin-packed Cardboard	30 pcs	--	--
Outer Box	24 skin-packed Cardboards per Outer Box	720 pcs	50*39*33 cm	3.5 Kg

KCLP0404CRSM

Item	Quantity	Total Parts	Size (L*W*H)	G.W.
skin-packed Cardboard	30 pcs per skin-packed Cardboard	30 pcs	--	--
Outer Box	16 skin-packed Cardboards per Outer Box	480 pcs	50*39*33 cm	2.8 Kg

KCLP0405CRSM

Item	Quantity	Total Parts	Size (L*W*H)	G.W.
skin-packed Cardboard	30 pcs per skin-packed Cardboard	30 pcs	--	--
Outer Box	22 skin-packed Cardboards per Outer Box	660 pcs	50*39*33 cm	3.6 Kg

KCLP0406CRSM

Item	Quantity	Total Parts	Size (L*W*H)	G.W.
skin-packed Cardboard	30 pcs per skin-packed Cardboard	30 pcs	--	--
Outer Box	33 skin-packed Cardboards per Outer Box	990 pcs	50*39*33 cm	4.3 Kg

Materials

Material	Top
PC HT	-30°...150°C
KCLP04xxCRSM Temperature resistance: long-term	-30°...105°C
KCLP04xxCRSM Temperature resistance: short exposure	up to + 120 °C

Notes:

- The optical values shown are the result of optical simulations carried out with LIGHTTOOLS, ASAP and ZEMAX software systems. The optical simulations are carried out on the basis of the typical values provided in the LED manufacturers' official datasheets. The photometric analysis has been carried out on physical samples.

Use and Maintenance

- DO NOT HANDLE OR INSTALL LENSES WITHOUT WEARING GLOVES, SKIN OILS MAY DAMAGE LENS OR LIGHT TRANSMISSION;
- CLEAN LENSES WITH MILD SOAP AND WATER AND A SOFT CLOTH;
- DO NOT USE ANY COMMERCIAL CLEANING SOLVENTS ON LENSES.

Disclaimer

Please note that flow lines and weld lines on the external surfaces of the lenses are acceptable if the optical performance of the lens is within the specifications.

Should you require further information, please contact Khatod for advice. All lens testing must be subject to identical conditions as Khatod test condition. Khatod Optoelectronic, Milan, Italy, manufactures lenses for LEDs. Any other use of the lens shall void our liability and warranty. The lenses are an inert component to be used in the manufacture of various products. Our warranty and liability are limited only to the manufacture of the lens. You may not modify, copy, distribute reproduce, license or alter the lens and related materials of Khatod. Khatod does not warrant against damages or defects arising out of the use or misuse of the products; against defects or damage arising from improper installation, or against defects in the product or in its components. No warranty of any kind, expressed or implied, is made regarding the safety of the products. The entire risk as to the quality or performance of the product is with the buyer. In no event shall Khatod be liable for any direct, indirect, punitive, incidental, special, consequential damages, or any damages whatsoever arising out of or connected with the use or misuse of the product. Khatod shall not have any obligation with respect to the product or any part thereof, whether based on contract, tort, strict liability or otherwise. Buyer assumes all risks and liability from use of the product. The laws of Milan, Italy govern this product warranty and liability and you hereby consent to the exclusive jurisdiction and venue of courts in Milan, Italy in all disputes arising out of or relating to the use of this product. Production, marketing, distribution, sale of these products as well as their possible modifications and variations are only exclusive right of Khatod Optoelectronic. No company can perform any of these actions without written permission released by Khatod Optoelectronic. The information contained in this document is proprietary of Khatod Optoelectronic and may change without notice.

REPRODUCTION PROHIBITED.